

Memo

Type of product			
Date of purchase			
Name		Tel	
Address			



REVERSE OSMOSIS SYSTEM

ERS-106AP

USER'S MANUAL

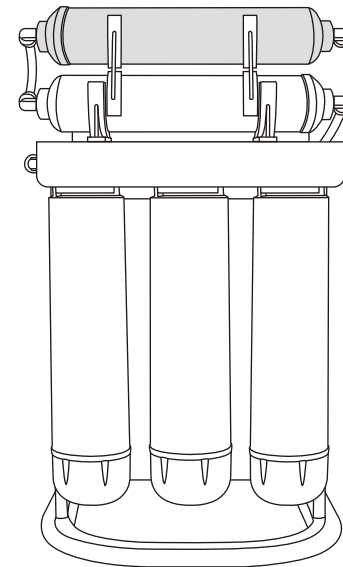

- 01 Introduction of ERS-106AP
- 02 What is reverse osmosis
- 03 Components & Selected filters
- 04 Cartridge filters
- 05 The parts of ERS-106AP
- 06 Tubing connection diagram
- 07 Installation diagram
- 08 Change filters
- 09 Change membrane
- 10 Operation regulation
- 12 The functions of Alkaline filter
- 13 FAQ
- 14 Maintenance checking list
- 15 Memo

Thank you very much for selecting Pure-Pro Water Corp.
In order to bring the best use of your system, please read the user's manual carefully before installation and follow the regulations.

Introduction of ERS-106AP

ERS-106AP Quick-change RO system

PurePro® Quick-Change RO system uses the most advanced water treatment technology: "Reverse Osmosis". Reverse Osmosis (RO) is recognized as one of the best available technologies for producing best quality drinking water. It's also the same method used by many bottled water companies to make safe and great tasting water. No other home water treatment system can offer you as much protection and reliability.

Quick-change cartridge filters

** Quick-Change RO systems are so easy to service!!

The newly designed quick-change RO system is user friendly with design simplicity in mind. It requires no tools for filter changes. Use twist and quick-change cartridge design makes filter changes fast, clean and easy. This space saving allows maximum use of your under counter space.

Specifications

- Production: 50 GPD / 189 LPD
- With a transformer, available in 110Volt, 220Volt or 240Volt (50/60Hz)
- Water storage tank: 3.2 gallons / 12.2 liters
- Operation pressure: 5- 80 psi
- Dimensions: (cm) 29(L) x 42.5(H) x 21(W) - system
(cm) 28 (L) x 28 (W) x 35 (H) - tank
- Weight: 8 kg - system
4 kg - tank

Maintenance checking list

Filters Date	1st stage	2nd stage	3rd stage	4th stage	5th stage	6th stage

FAQ

Q: What is the guarantee on the PurePro system ?

The PurePro system (excluding filters) is guaranteed for 1 year for material and workmanship. All defective parts will be replaced free within the first year under natural breakdown. The membrane has one year pro-rated guarantee.

Q: What factors affect the quantity and the quality of the water production?

There are four major variables to consider:

1. **Pressure**-The greater the water pressure, the better water quantity and quality it produced. Water pressure of 60 PSI is ideal.
2. **Temperature**-76°F is the ideal water temperature for R.O. 40°F water will cause the production of R.O. water to fall to half of that at 76°F. The maximum water temperature recommended is 85°F.
3. **Total Dissolved Solids (TDS)**-The higher the amount of dissolved contaminants in the water, the lower the quantity of water produced. A high level of TOTAL DISSOLVED SOLIDS can be overcome with additional water pressure.
4. **Membrane**-Different membranes have different characteristics. Some produce more water than others; some have better contaminant rejection capabilities; some have greater resistance to chemical abrasion for longer life. PurePro system includes TW30-1812-50 The Thin Film Composite (TFC) membranes combine the best of these characteristics and are considered the finest membrane in the world.

Q: Can the PurePro system be connected to an extra faucet?

It only takes a 1/4" tee and tubing to run the water to a refrigerator or a extra faucet. Some families run PurePro system to all of their bathrooms.

Q: What does the PurePro series drinking water taste like?

The taste of the PurePro water depends on the amount of contaminants in the tap water originally. If 95% of dissolved minerals and chemicals are removed, the R.O. water may taste like distilled water (no minerals), bottled water (low mineral), or natural spring water (moderate mineral content).

What is reverse osmosis

Reverse osmosis was originally designed to make sea water drinkable for the navy. It is ideal for anyone on a low sodium diet. An R.O. membrane has a pore size much smaller than bacteria virus, or the cryptosporidium parasite. When functioning properly it will remove all microorganisms from tap water and produce sterile water. Reverse osmosis is the reversal of the natural flow of osmosis. In a water purification system, the goal is not to dilute the salt solution, but to separate the pure water from the salt and other contaminants. When the natural osmotic flow is reversed, water from the salt solution is forced to pass through the membrane in the opposite direction by application of pressure-thus the term REVERSE OSMOSIS. Through this process, we are able to produce pure water by screening out the salts and other contaminants.

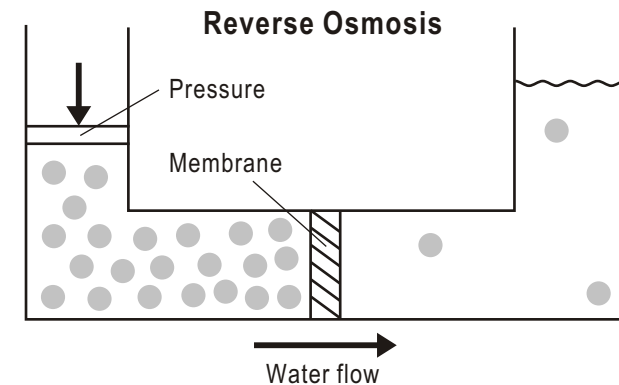

Components & Selected filters

Components

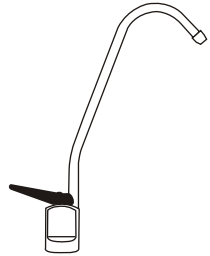

Standard faucet

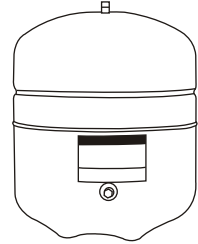

Water storage tank

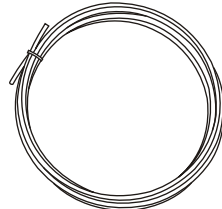

Tubing

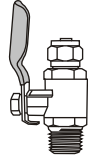

Deliver-valve

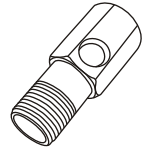

Water supply connector

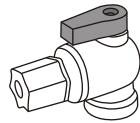

Tankball shut-off valve

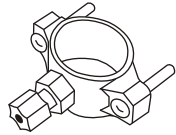

Drain saddle

Selected filters



Mineral cartridge filter

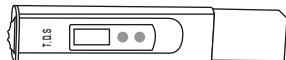

TDS meter



Infra-red cartridge filter



UV water sterilizer

ERS-106 Quick-Change RO Systems

The functions of Alkaline Filter

The Alkaline filter changes the acidic RO water into a perfect Natural Alkali Calcium Ionized Water. The PurePro® Alkaline filter simply gives back minerals such as ionized calcium, magnesium, sodium, potassium ion, which were taken away while purifying the water. The PurePro® Alkaline filter is effective and give the water pH value of 8.00~9.50

- Produces perfectly ph-balanced alkaline water, helps minimize the fluctuations of your body's pH.
- Turn acidic drinking water into alkali calcium ion water.
- This natural calcium, magnesium, sodium, potassium ions can be absorbed 100% by the body.
- It is easily absorbed in the body because it has structurally smaller molecules which help the body take in more water and replenish quickly lost water.
- Makes the water cleaner and healthier.
- This filter improves the qualities of clean water by adding necessary for proper human development and health minerals, such as Calcium, Magnesium, Sodium, Potassium and others readily found in many natural mineral waters.
- Mainly installed with RO systems to complement their absolute filtration qualities.

Technical Specifications:

- Diameter: 53mm
- Length: 254mm
- Max. flow rate: 250 l/24h
- Max. pressure: 6bar
- Max. temperature: 51°C
- Balance pH: pH8.00~9.50
- Capacity: 3000 liters
- Cations in filtered water:
 - Ca²⁺: 55mg/l
 - Mg²⁺: 18mg/l
 - Na⁺: 22mg/l
 - K⁺: 8.5mg/l
- Anions in filtered water:
 - CO₃²⁻: 8mg/l
 - SO₄²⁻: 0.2mg/l
 - Cl⁻: 0.6mg/l
 - F⁻: 0.03mg/l

The alkaline water after the PurePro® alkaline filter has perfectly balanced proportions of minerals necessary for healthy development of the human body. The Alkaline filter changes the acidic RO water into a perfect natural alkaline water. It will reduce acidity in the body and it will produce natural calcium, magnesium, sodium and potassium ions that can be absorbed 100% in the human body.

ERS-106 Quick-Change RO Systems





Operation regulation

- A. With everything connected, turn on the water check for leaks.
- B. Make sure the storage tank shut-off valve is "OFF". Open the sink top faucet.
- C. Within a few minutes (up to 15) the water will start to run from the faucet slowly.
- D. Let the water run for at least 30 minutes. This flushes the carbon filters on firsttime use.
- E. After initial flushing, open the shut-off valve on the tank and close the sink top faucet.
- F. Tank will now full of water (usually 2 to 3 hours) after the tank has filled. Open the sink top faucet and drain all water until the storage tank is empty and there is only a small flow from the sink top faucet.*** DO NOT USE FIRST TANK OF WATER.***
- G. Close the sink top faucet. The system is now ready for use.
- H. Change filters regularly every 6 to 12 months and have the membrane checked annually.

Caution

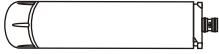
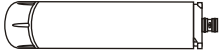
1. Do not use hot water (over 45°C)!
2. Do not freeze the machine!
3. Switch off electricity and water source if away for more than 5 days, and drain out pure water.

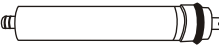
Cartridge filters

Cartridge Filters	Filter Description	Service Life
Stage 1 5 Micron Sediment Filter 	S300ST With only five micron rating. It is effective in removing dirt, rust and sand particles.	6 Months
Stage 2 GAC Carbon Filter 	S300ND It takes out 99% of the chlorine and organic chemicals. It provides enhanced reduction of taste, odor, and color.	6 Months
Stage 3 CTO Carbon Filter 	S300RD It takes out 99% of the chlorine and organic chemicals. It provides enhanced reduction of taste, odor, and color.	6 Months
Stage 4 TFC Membrane 	A thin film composite (TFC) high quality membrane that processes 50 gallons per day. It remove the following hard water contaminants that may be present in your water: lead, cooper, barium, chromium, mercury, sodium, cadmium, fluoride, nitrite, nitrate, and selenium.	2 Years
Stage 5 Post Carbon Filter 	NSF approved. This post carbon filter is designed to improve taste. It removes any residual impurities and odors from the tank and provides a finer conditioning of pure water.	1 Year
Stage 6 Alkaline Filter 	The Alkaline filter changes the acidic RO water into a perfect Natural Alkali Calcium Ionized Water. The Alkaline filter simply gives back minerals such as ionized calcium, magnesium, sodium, potassium ion, which were taken away while purifying the water.	1 Year

The parts of ERS-106AP

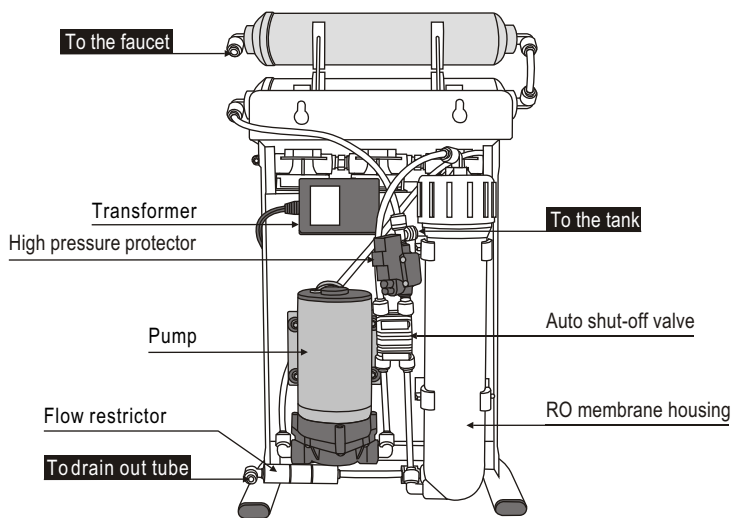
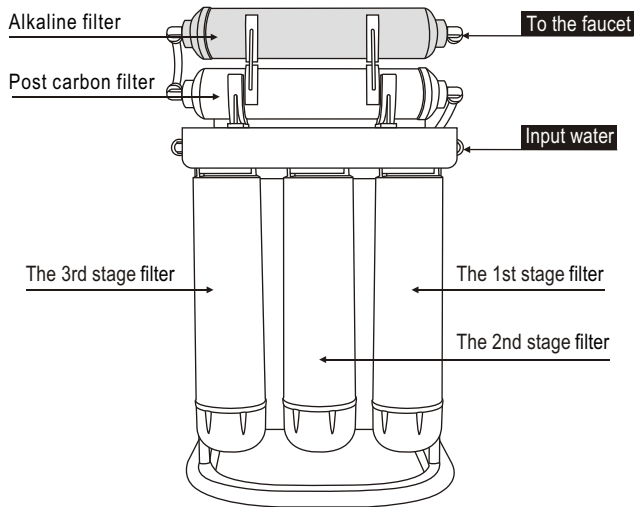

ERS-106 Quick-Change RO Systems

Operation regulation

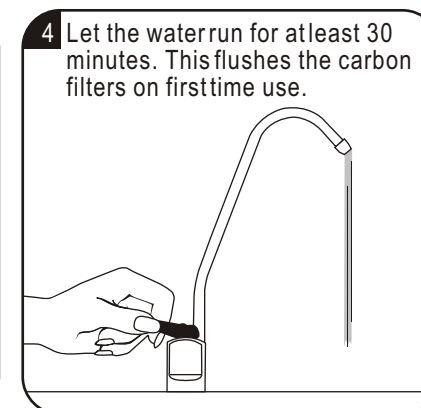
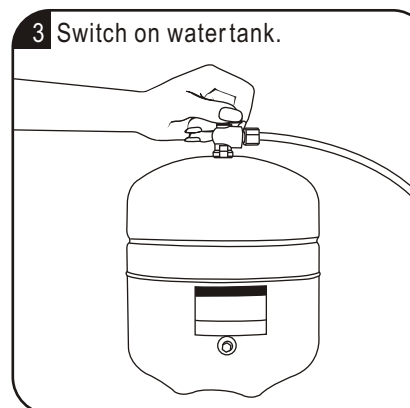
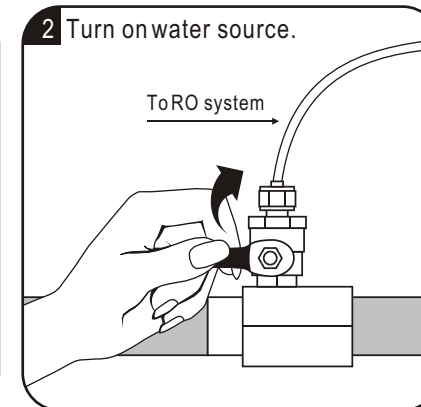
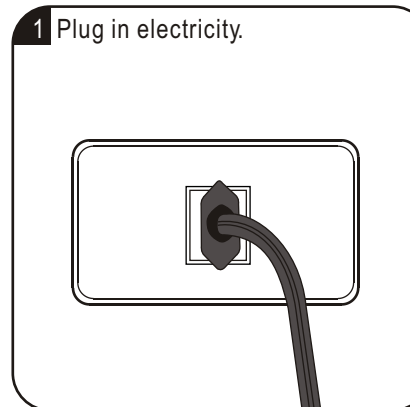

ERS-106 Quick-Change RO Systems

Change membrane

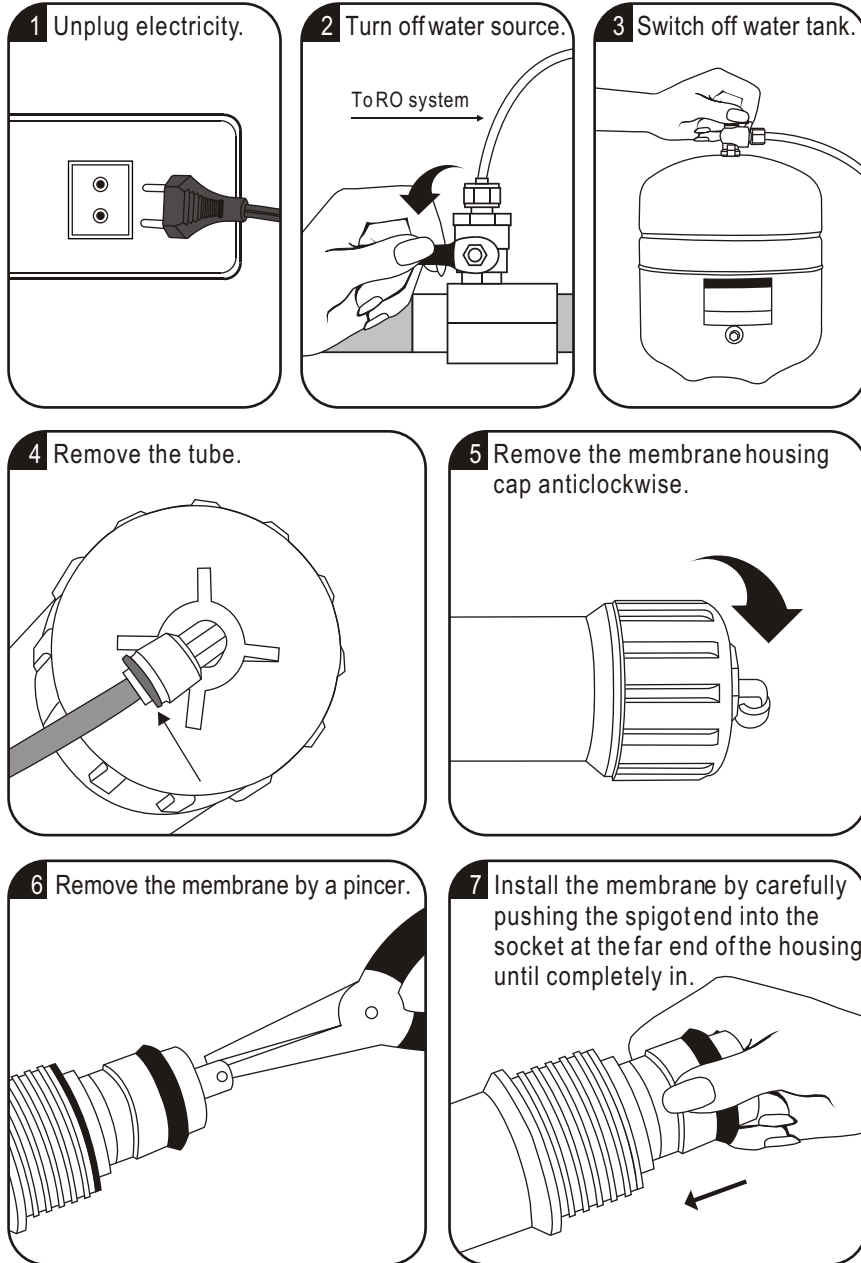

ERS-106 Quick-Change RO Systems

PUREPRO
DRINKING WATER SYSTEM

Tubing connection diagram

CONNECTING THE COLOR TUBING:

- A. Connect the WHITE tubing to the water supply connector.
- B. Connect the BLUE tubing to the sink top faucet.
- C. Connect the BLACK tubing to the drain saddle.
- D. Connect the RED tubing to the storage tank.

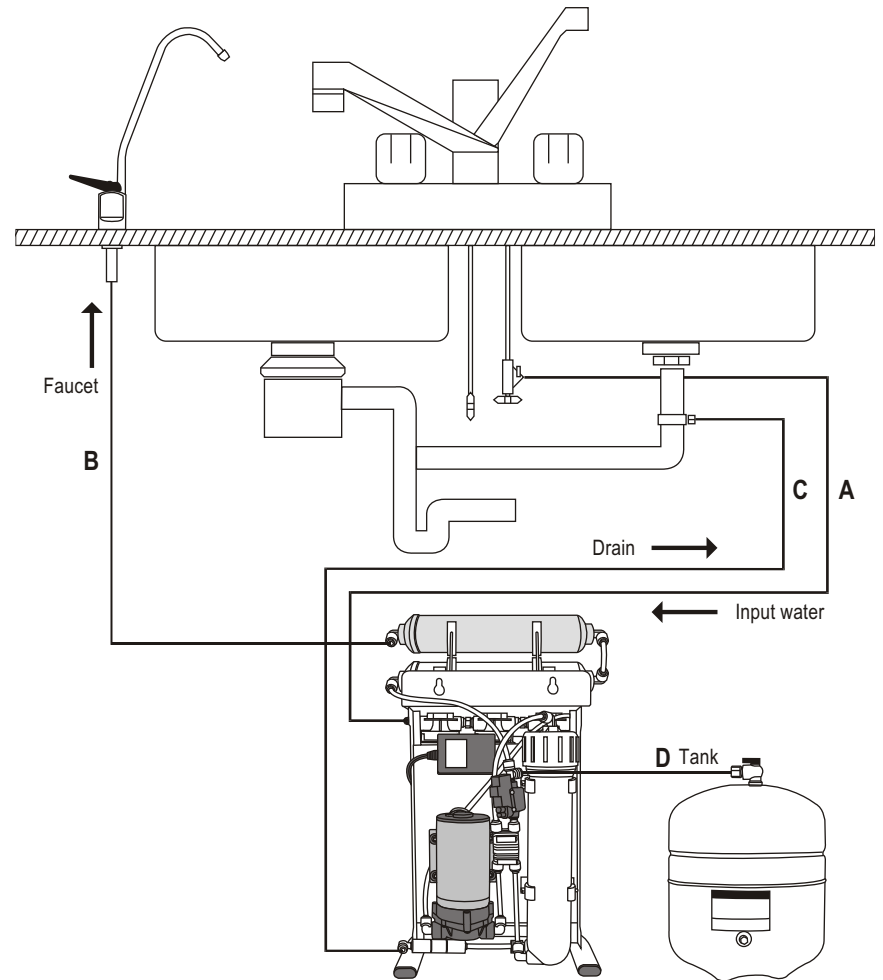

ERS-106 Quick-Change RO Systems

PUREPRO
DRINKING WATER SYSTEM

Installation diagram

Input water :

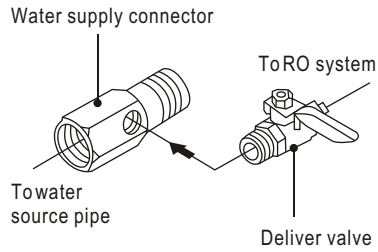

Install water tank :

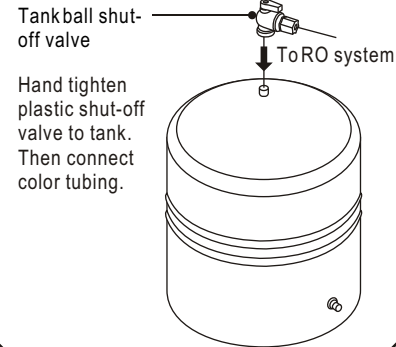

Install faucet :

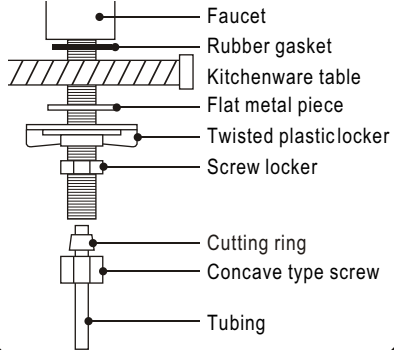

Install drain saddle :

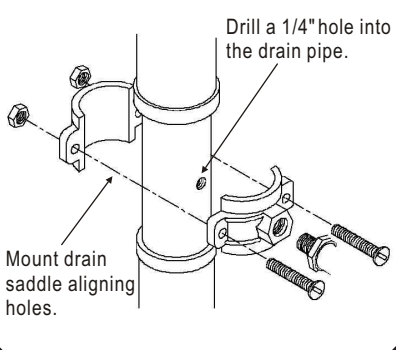

Assemble membrane :

- Remove the tube.
- Remove the membrane housing cap.
- Install the membrane by carefully pushing the spigot end into the socket at the far end of the housing until completely in.

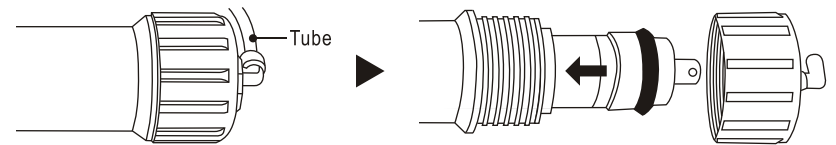

Change filters

1 Unplug electricity.

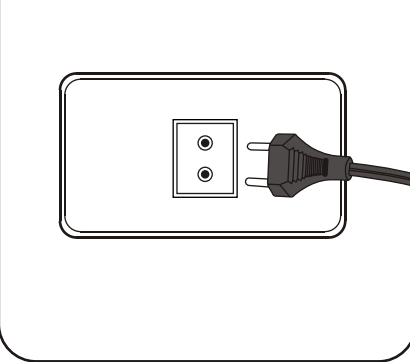

2 Turn off water source.

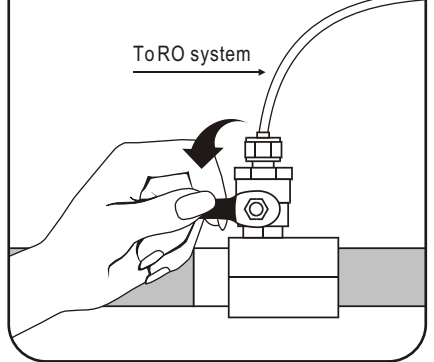

3 Switch off water tank.

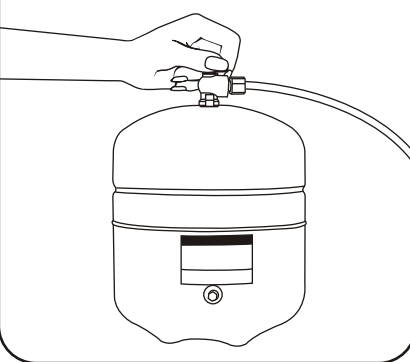

4 Loose the used pre-filter clockwise and remove it.

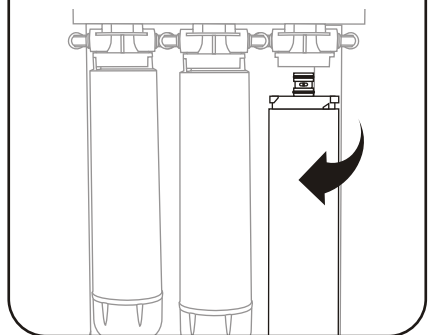

5 Screw in and install the new filter anticlockwise.

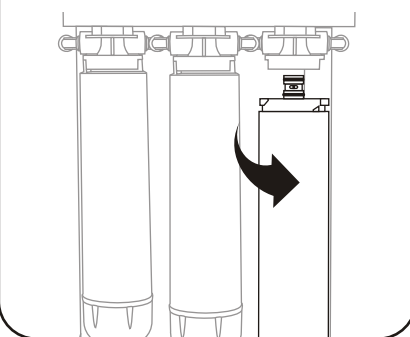

6 Drain out 1 Gallon of water to purify replacement filters.

