

Memo

Type of product	S500-P		
Date of purchase			
Name		Tel	
Address			



REVERSE OSMOSIS SYSTEM

S500-P

USER'S MANUAL

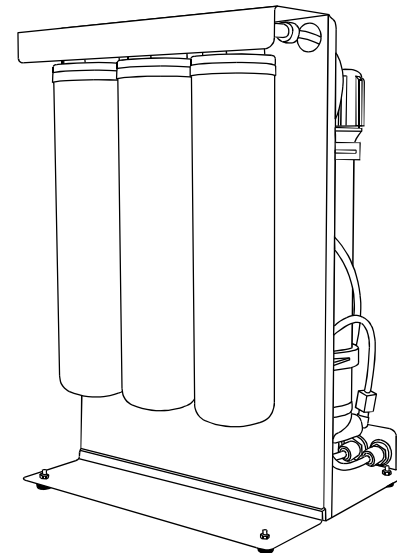

- 01 Introduction of S500-P
- 02 What is reverse osmosis
- 03 Components & Selected filters
- 04 Cartridge filters
- 05 The parts of S500-P
- 06 Tubing connection diagram
- 07 Installation diagram
- 08 Change filters
- 09 Change membrane
- 10 Operation regulation
- 12 FAQ
- 14 Maintenance checking list
- 15 Memo

Thank you very much for selecting Pure-Pro Water Corp.
In order to bring the best use of your system, please read the user's manual carefully before installation and follow the regulations.

Introduction of S500-P

◆S500-Quick-change cartridges RO systems

S500 reverse osmosis system uses the most advanced water treatment technology available. Reverse Osmosis is recognized as one of the best available technologies for producing high quality drinking water. It's also the same method used by many bottled water companies to make safe and great tasting drinking water.

The newly designed S series S500 is user friendly with design simplicity in mind. It requires no tools for filter changes. Use twist and quick-change cartridge design makes filter changes fast, clean and easy. The stainless steel tanks is durable and will not rust or dent. This space saving allows maximum use of your under counter space.

◆Specifications

- Production: 50 GPD / 189 LPD
- Water storage tank: 3.2gallons / 12.2 liters
- With a booster pump (optional): Input in AC 110Volt, 220Volt or 240Volt (50/60Hz)
- Operation pressure: 10 -100 psi
- Dimensions: (cm)27 (L) x 39.8(H) x 22.5 (W)
- Weight: 8.5 kg

Maintenance checking list

Filters Date	1st stage	2nd stage	3rd stage	4th stage	5th stage	Other items

FAQ

Q: How will the Pure-Pro series water affect mixed beverages?

Because reverse osmosis removes invisible contaminants that mask flavor, it allows the natural taste of your beverages to come through. You will be able to use less coffee and still get the full flavor. Concentrated beverages like orange juice will taste tangier. You will probably be drinking a lot more water as well, since many people drink soda, Kool-Aid, concentrated juices, and beer as an alternative to bad-tasting tap water. Also, Pure-Pro eliminates most of the lime build up on drip coffee makers, preventing the need for frequent cleaning. No longer will you find the white scum on the inside of pans after boiling water.

Q: How much water does the Pure-Pro system produce ?

Under ideal conditions, the RE1812-50 TFC membrane is rated at 50gallons of production per day. Under the average conditions, the consumer can expect 50 gallons of product water per day. But that's still a lot of water for the average household's drinking and cooking requirements.

Q: Don't people need minerals removed from the water ?

Most of the minerals that we receive are from the foods we eat. Only a very small percentage comes from the water we drink.

Q: What is the maintenance schedule for the Pure-Pro System ?

The three pre-filter cartridges should be changed every 6 months. The 5 micron sediment cartridge filter is the first one; the second is a carbon cartridge filter, and the third one is a 1 micron sediment filters. (some systems comes with the Extruded carbon filter.) Failure to change the cartridge every 6 months may cause chlorine to destroy the membrane.

What is reverse osmosis

Reverse osmosis was originally designed to make sea water drinkable for the navy. It is ideal for anyone on a low sodium diet. An R.O. membrane has a pore size much smaller than bacteria virus, or the cryptosporidium parasite. When functioning properly it will remove all microorganisms from tap water and produce sterile water. Reverse osmosis is the reversal of the natural flow of osmosis. In a water purification system, the goal is not to dilute the salt solution, but to separate the pure water from the salt and other contaminants. When the natural osmotic flow is reversed, water from the salt solution is forced to pass through the membrane in the opposite direction by application of pressure-thus the term REVERSE OSMOSIS. Through this process, we are able to produce pure water by screening out the salts and other contaminants.

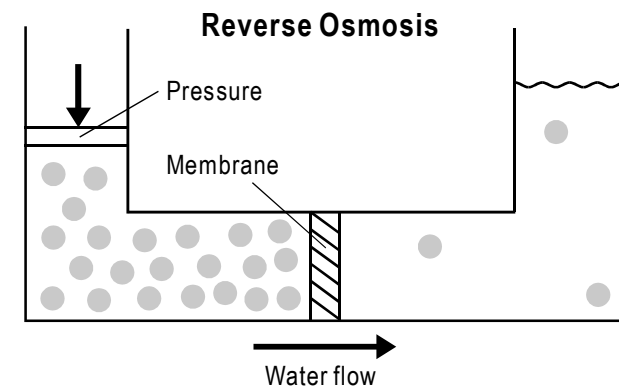

Components & Selected filters

◆ Components

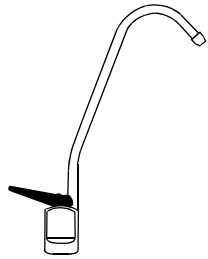

Standard faucet

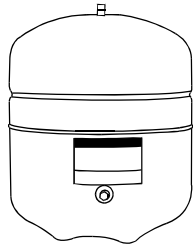

Water storage tank

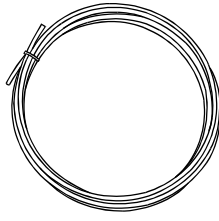

Tubing

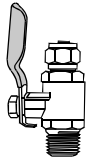

Deliver-valve

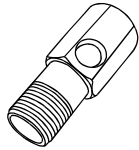

Water supply connector

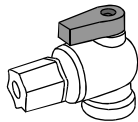

Tank ball shut-off valve

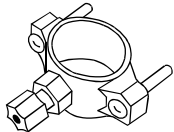

Drain saddle

◆ Selected filters

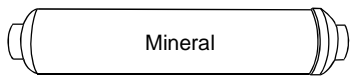

Mineral cartridge filter

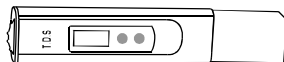

TDS meter

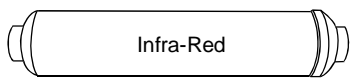

Infra-red cartridge filter



UV water sterilizer

S500-P Reverse Osmosis Drinking Water Systems

PUREPRO
DRINKING WATER SYSTEM

FAQ

Q: What is the guarantee on the Pure-Pro system ?

The Pure-Pro System (excluding filters) is guaranteed for 1 year for material and workmanship. All defective parts will be replaced free within the first year under natural breakdown. The membrane has one year pro-rated guarantee.

Q: What factors affect the quantity and the quality of the water production?

There are four major variables to consider:

- 1. Pressure**-The greater the water pressure, the better water quantity and quality it produced. Water pressure of 60 PSI is ideal.
- 2. Temperature**-76°F is the ideal water temperature for R.O. 40°F water will cause the production of R.O. water to fall to half of that at 76°F. The maximum water temperature recommended is 85°F.
- 3. Total Dissolved Solids (TDS)**-The higher the amount of dissolved contaminants in the water, the lower the quantity of water produced. A high level of TOTAL DISSOLVED SOLIDS can be overcome with additional water pressure.
- 4. Membrane**-Different membranes have different characteristics. Some produce more water than others; some have better contaminant rejection capabilities; some have greater resistance to chemical abrasion for longer life. Pure-Pro system includes RE1812-50 The Thin Film Composite (TFC) membranes combine the best of these characteristics and are considered the finest membrane in the world.

Q: Can the Pure-Pro system be connected to an extra faucet?

It only takes a 1/4" tee and tubing to run the water to a refrigerator or a extra faucet. Some families run Pure-Pro system to all of their bathrooms.

Q: What does the Pure-Pro series drinking water taste like?

The taste of the Pure-Pro water depends on the amount of contaminants in the tap water originally. If 95% of dissolved minerals and chemicals are removed, the R.O. water may taste like distilled water (no minerals), bottled water (low mineral), or natural spring water (moderate mineral content).

S500-P Reverse Osmosis Drinking Water Systems

PUREPRO
DRINKING WATER SYSTEM





Operation regulation

- A. With everything connected, turn on the water check for leaks.
- B. Make sure the storage tank shut-off valve is "OFF". Open the sink top faucet.
- C. Within a few minutes (up to 15) the water will start to run from the faucet slowly.
- D. Let the water run for at least 30 minutes. This flushes the carbon filters on first time use.
- E. After initial flushing, open the shut-off valve on the tank and close the sink top faucet.
- F. Tank will now full of water (usually 2 to 3 hours) after the tank has filled. Open the sink top faucet and drain all water until the storage tank is empty and there is only a small flow from the sink top faucet. *** DO NOT USE FIRST TANK OF WATER. ***
- G. Close the sink top faucet. The system is now ready for use.
- H. Change filters regularly every 6 to 12 months and have the membrane checked annually.

Caution

1. Do not use hot water (over 45°C)!
2. Do not freeze the machine!
3. Switch off electricity and water source if away for more than 5 days, and drain out pure water.

Cartridge Filters

Cartridge Filters	Filter Description	Service Life
<p>Stage 1 5 Micron Sediment Filter</p> 	<p>S300ST With only five micron rating. It is effective in removing dirt, rust and sand particles.</p>	6 Months
<p>Stage 2 GAC Carbon Filter</p> 	<p>S300ND It takes out 99% of the chlorine and organic chemicals. It provides enhanced reduction of taste, odor, and color.</p>	6 Months
<p>Stage 3 CTO Carbon Filter</p> 	<p>S300RD It takes out 99% of the chlorine and organic chemicals. It provides enhanced reduction of taste, odor, and color.</p>	6 Months
<p>Stage 4 TFC Membrane</p> 	<p>A thin film composite (TFC) high quality membrane that processes 50 gallons per day. It remove the following hard water contaminants that may be present in your water: lead, cooper, barium, chromium, mercury, sodium, cadmium, fluoride, nitrite, nitrate, and selenium.</p>	2 Years
<p>Stage 5 Post Carbon Filter</p> 	<p>This carbon post filter removes objectionable tastes and odors to enhance the quality of your drinking water. We are using NSF approved post carbon to guarantee the taste of water.</p>	1 Year

The parts of S500-P

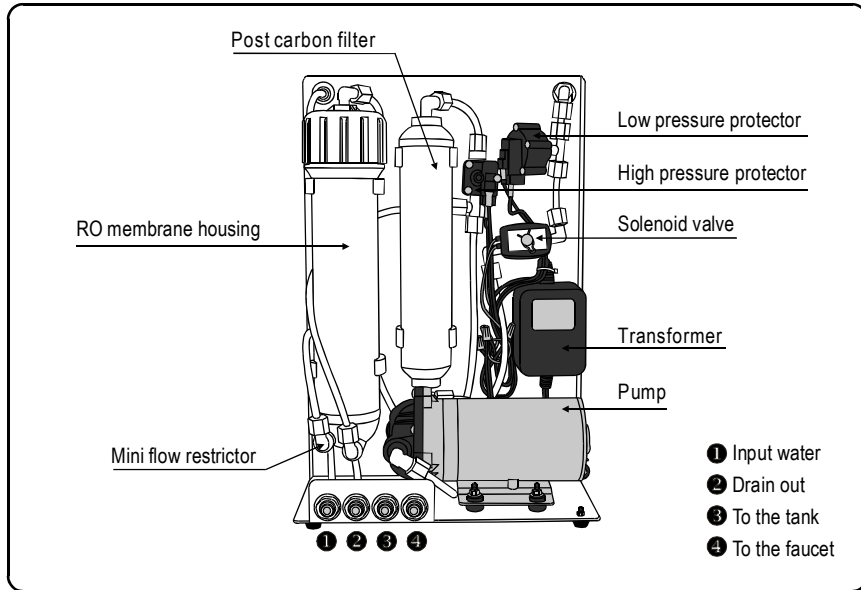
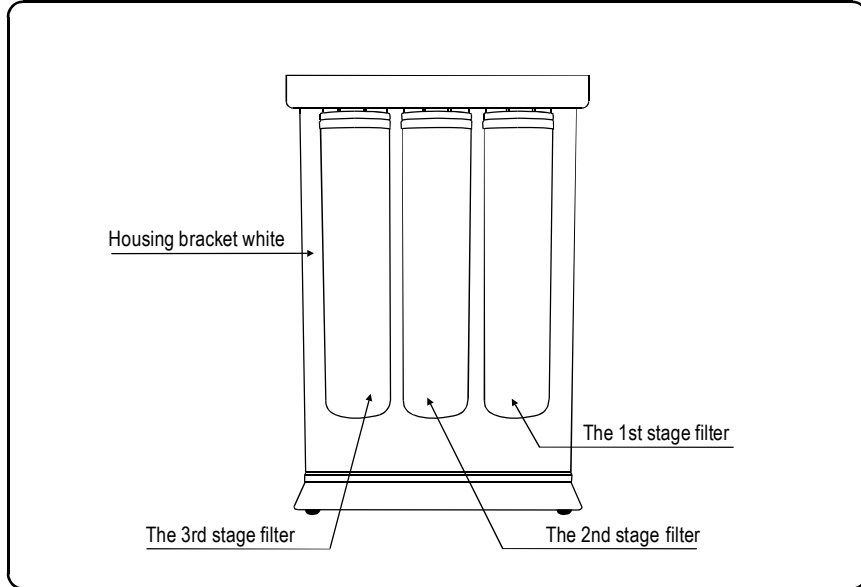

S500-P Reverse Osmosis Drinking Water Systems

Operation regulation

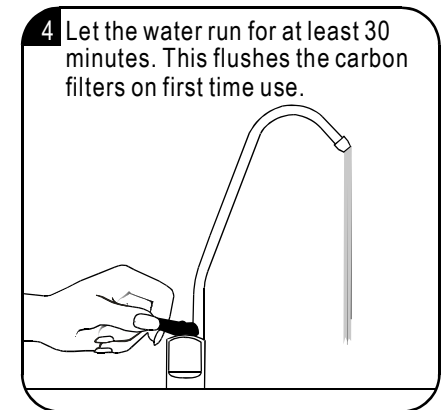
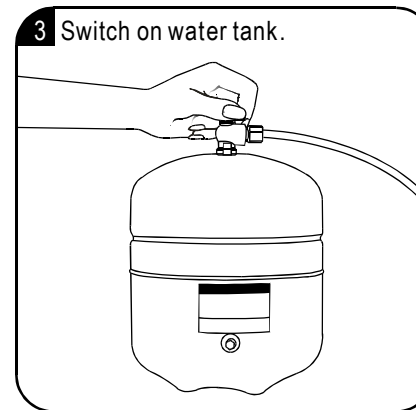
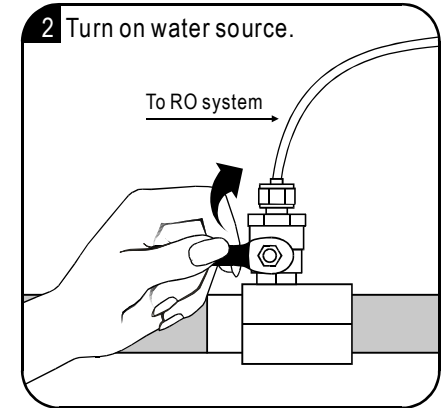
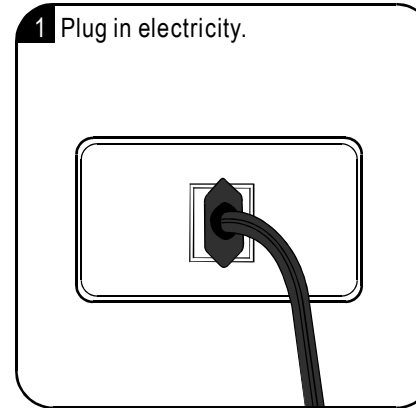

S500-P Reverse Osmosis Drinking Water Systems

Change membrane

1 Unplug electricity.

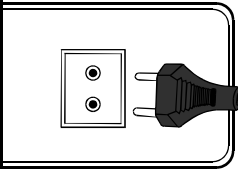

2 Turn off water source.

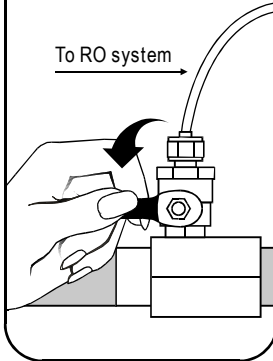

3 Switch off water tank.

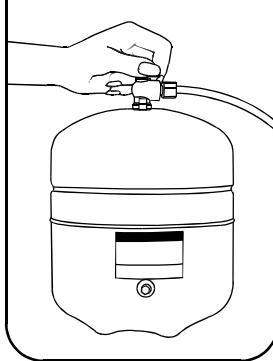

4 Loosen the Jaco fitting anticlockwise.

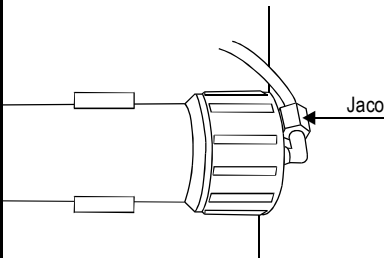

5 Remove the membrane housing cap anticlockwise.

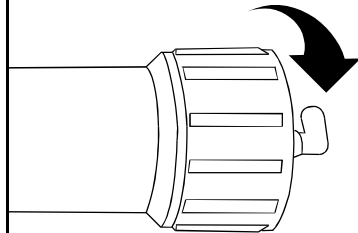

6 Remove the membrane by a pincer.

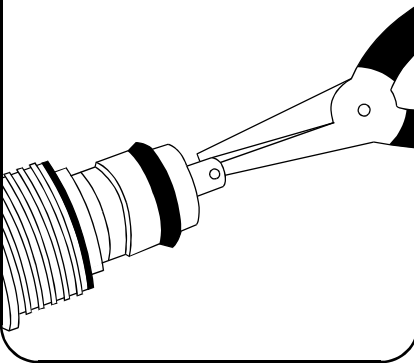

7 Install the membrane by carefully pushing the spigot end into the socket at the far end of the housing until completely in.

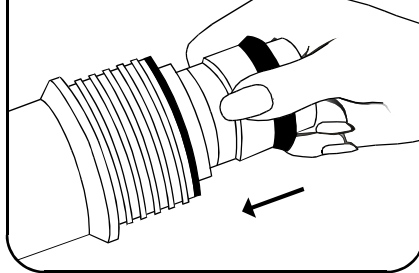

S500-P Reverse Osmosis Drinking Water Systems

PUREPRO
DRINKING WATER SYSTEM

Tubing connection diagram

CONNECTING THE COLOR TUBING:

- A. Connect the WHITE tubing to the water supply connector.
- B. Connect the BLUE tubing to the sink top faucet.
- C. Connect the BLACK tubing to the drain saddle.
- D. Connect the RED tubing to the storage tank.

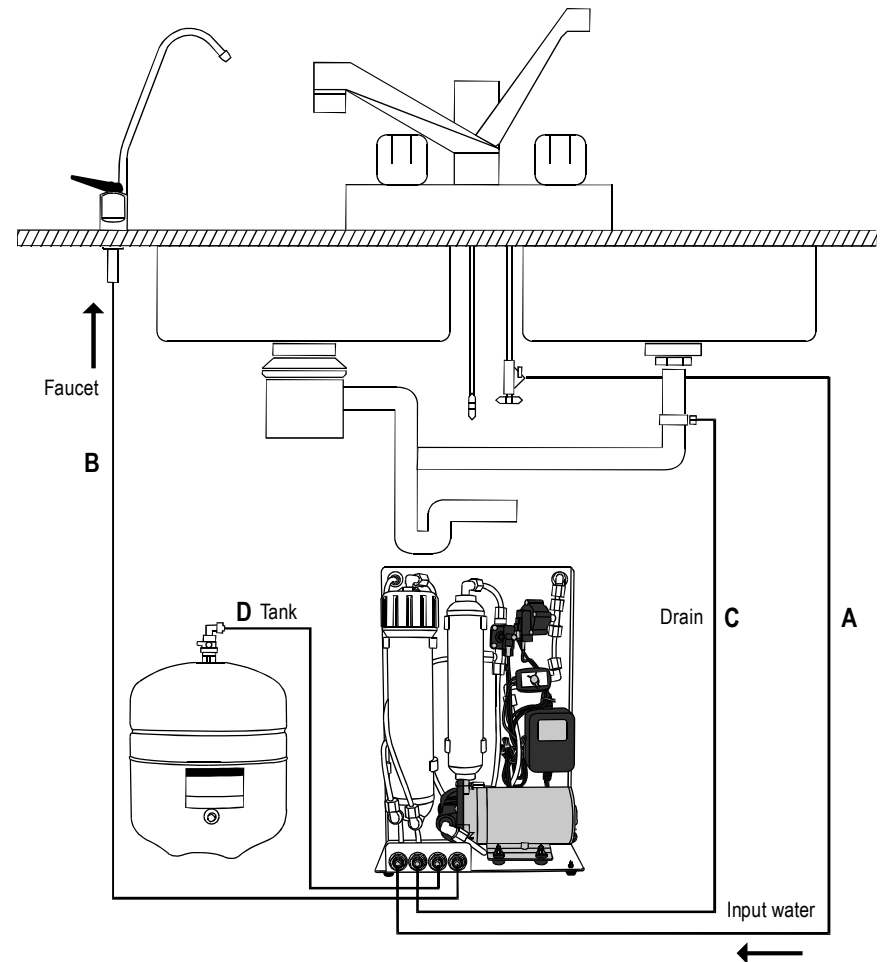

S500-P Reverse Osmosis Drinking Water Systems

PUREPRO
DRINKING WATER SYSTEM

Installation diagram

Input water :

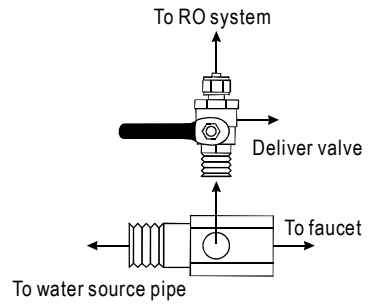

Install water tank :

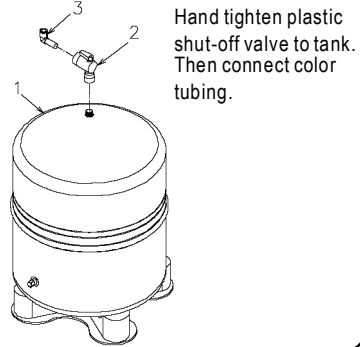

Install European ceramic faucet :

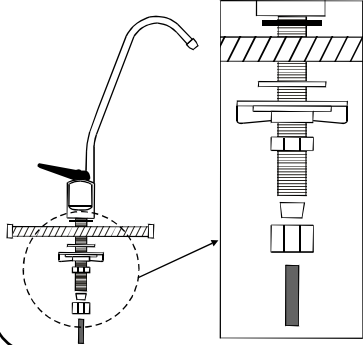

Install drain saddle :

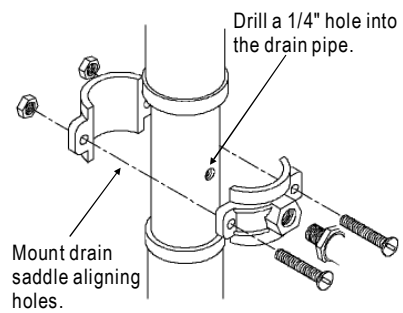

Assemble membrane :

1. Remove the membrane housing cap.
2. Replace the membrane.

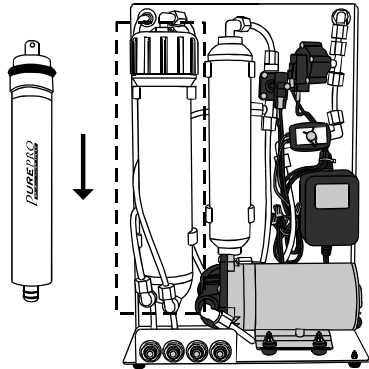

Change filters

1 Unplug electricity.

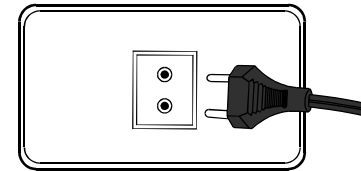

2 Turn off water source.

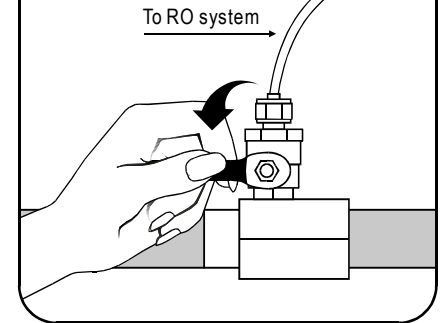

3 Switch off water tank.

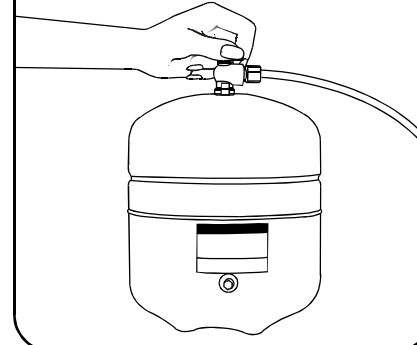

4 Loosen the used pre-filter clockwise and remove it.

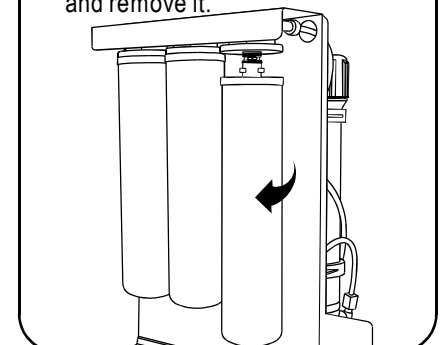

5 Screw in and install the new filter anticlockwise.

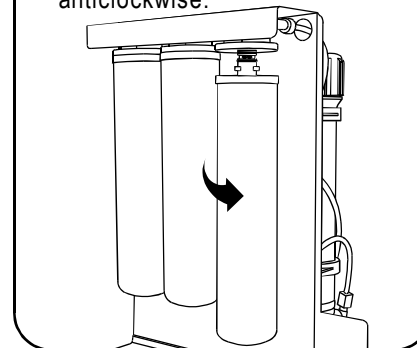

6 Drain out 1 Gallon of water to purify replacement filters.

