

Memo

Type of product	WF-20		
Date of purchase			
Name		Tel	
Address			

PURE-PRO 07 REVERSE OSMOSIS SYSTEM

PUREPRO
DRINKING WATER SYSTEM

WF-20

Whole house water filter systems (BIG BLUE)

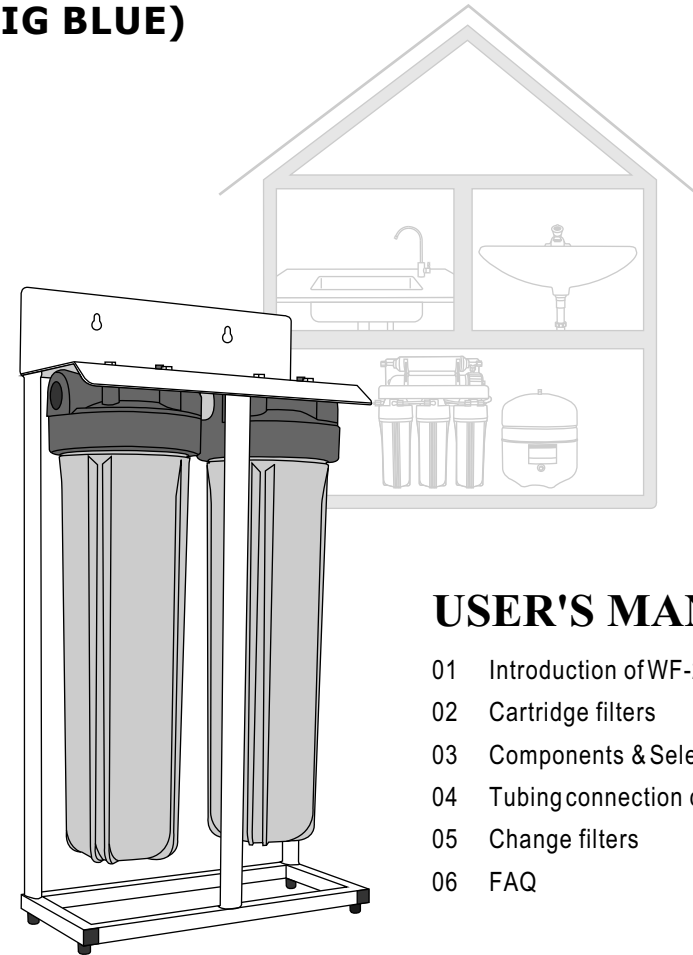

USER'S MANUAL

- 01 Introduction of WF-20
- 02 Cartridge filters
- 03 Components & Selected filters
- 04 Tubing connection diagram
- 05 Change filters
- 06 FAQ

Thank you very much for selecting Pure-Pro Water Corp.

In order to bring the best use of your system, please read the user's manual carefully before installation and follow the regulations.

WF-20 Whole house water filter systems

PUREPRO
DRINKING WATER SYSTEM

Introduction of WF-20

WF-20

This whole house water filter with 20" single replaceable filter provides you with great tasting water. It removes hundreds of contaminants from your water. Water travels through 2 stages of filtration

- First water travels through a five micron filter pad, GAC, and another one micron pad and removes hundreds of contaminants from your water
- Conveniently provides 10,000 gallons of quality water. Great for homes, apartments and offices.

Features

- Pressure Release Valve
- Wall Bracket
- Easy Filter Changes
- Compact
- Available in 1" NPT input/output

Operating Data:

- Max. Pressure: 125 psi
- Max. Temperature: 120°F (50°C)

NOTE:

- Filter housing must be protected against freezing
- Must be operated under recommended pressure
- Do not install filter housings to direct sunlight

WF-20 Whole house water filter systems

PUREPRO
DRINKING WATER SYSTEM

FAQ

Q: How long does the WF-20 whole house water filter system last?

The WF-20 unit is ideal for a 10,000 gallon capacity at 8 gpm, the highest certified capacity of any whole house water filter system. The main filter unit is easily replaced, and only needs to be replaced every 6 months ; the sediment pre-filter (EQ-304) should be replaced every 3-4 months.

Q: What are the benefits of whole house filtration?

By filtering all the water that enters your home, you not only greatly enhance the healthfulness of your household water, but you also dramatically improve your indoor air quality. It removes radon, VOCs, pesticides, metals, and will reduce TDS down to 5 microns and will alkalize the water. The WF-20 will also raise the pH of your water to around 7.5. Every home has an elevated level of chloroform gas present due to the vaporization of chlorine... from tap and shower water. Chlorine vapors are a suspected cause and irritant of respiratory problems such as asthma, bronchitis, and allergies. Filtered water will benefit every aspect of your family's health.

Q: If I put in a whole house unit, do I still need the other counter or shower units?

The shower system is not needed, but the use of the drinking water filter is still recommended because it removes more contaminants, and after water goes through the whole house filter, the house's plumbing will introduce new contamination like lead.

Q: Does the whole house filter system have any benefits for laundry and/or dishwashing?

Definitely. Clothes will not have VOCs and chlorine embedded in them to irritate skin, colors will last longer with the chlorine removed as well as look newer. The dishwasher releases more VOCs and chloroform into the household indoor air than any other source besides the shower. The system prevents this toxic gas from being released. Filtered water in the dishwasher also reduces film or soap scum on dishes. For both laundry and dishwashing, filtered water reduces the amount of detergent you need to use in each cycle.

WF-20 Whole house water filter systems

PUREPRO
DRINKING WATER SYSTEM

Change filters

1. Turn off water source.
2. Open housings clockwise with a wrench.

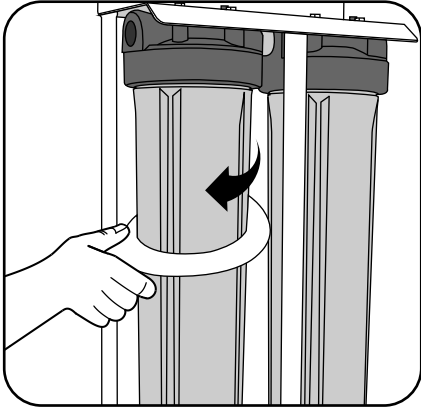

3. Put the replacement filters in the housings and double O' ring.

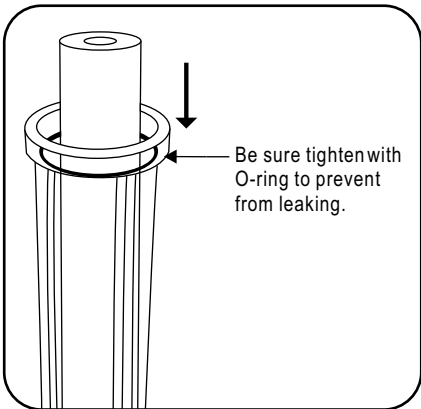

Drain out 1 Gallon of water to purify replacement filters.

Cartridge filters

Filter Description

<p align="center"><u>Stage 1</u></p> <p align="center">5 Micron Sediment Filter</p> <p>With only five micron rating. It is effective in removing dirt, rust and sand particles.</p>	<p align="center"><u>Stage 2</u></p> <p align="center">GAC Carbon Filter</p> <p>It takes out 99% of the chlorine and organic chemicals. It provides enhanced reduction of taste, odor, and color.</p>
<p align="center">Service Life</p> <p align="center">6 Months</p>	<p align="center">Service Life</p> <p align="center">6 Months</p>

Components & Selected filters

Components

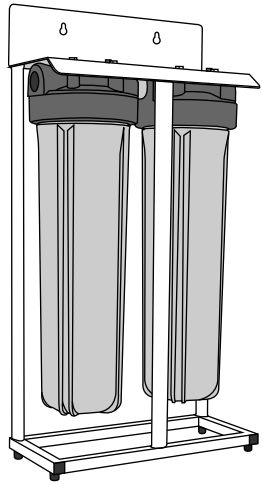

WF-20

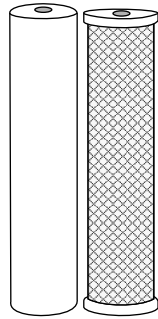

Cartridge filter

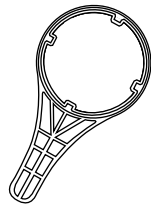

Housing wrench

Selected filters

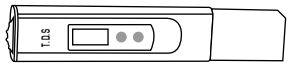

TDS meter



UV



Shower filter

WF-20 Whole house water filter systems

Tubing connection diagram

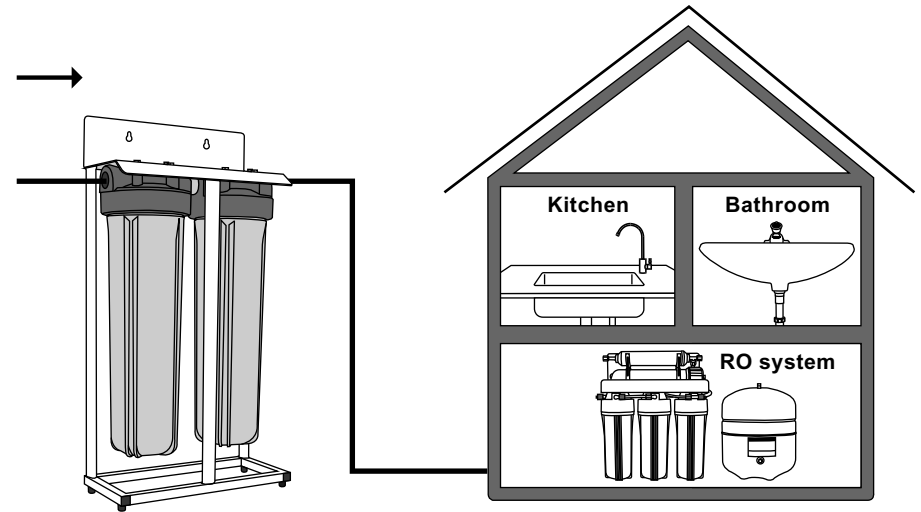

Whole House Filter

WF-20 Whole house water filter systems