

Memo

Type of product			
Date of purchase			
Name		Tel	
Address			

PURE-PRO 07 REVERSE OSMOSIS SYSTEM

PUREPRO
DRINKING WATER SYSTEM

WATER FILTRATION SYSTEMS

RS2000

USER'S MANUAL

- 01 Introduction of RS2000
- 02 Cartridge filters
- 03 Components & Other selections
- 04 Tubing connection diagram
- 05 Installation diagram
- 06 Change filters

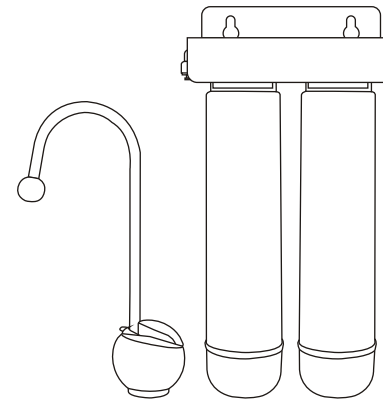

Thank you very much for selecting Pure-Pro Water Corp.
In order to bring the best use of your system, please read the user's manual carefully before installation and follow the regulations.

RS2000 Easy-change cartridge water filters

PUREPRO
DRINKING WATER SYSTEM

Introduction of RS2000

RS2000 Undersink water filters

Our RS2000 filters safely and effectively remove microorganisms like Giardia and Cryptosporidium from your water protecting you and your family from parasitic illnesses caused by these contaminants.

The patented quick-change filter technology also improves the taste and overall quality of your water by reducing the amount of Lead, Chlorine, Asbestos and other impurities often found in water supplies.

Efficient and easy to use, our RS2000 Countertop & Under sink water filters provide 1500 gallons (four to six months worth) of quality water and connecting directly to your tap, this water filtration product is convenient and practical. This unit will purify up to 1500 gallons of water by removing lead and other heavy metals as well as chlorine, bad tastes and odors.

Features

- Complete 2 stage water filter system.
- Use twist and quick-change cartridge design makes filter changes fast, clean and easy.
- Feed water connector & deliver valve
- Completely Assembled & Water leaking testing
- 100% Factory Tested and Sterilized Ready for Installation.
- European design goldentype faucet.(optional)

Specifications

- Dimensions: (cm) 17.0 (L) x 33.0 (H) x 9.0 (W)
- Weight: 4.5 kg

Change filters

1. Turn off water source.

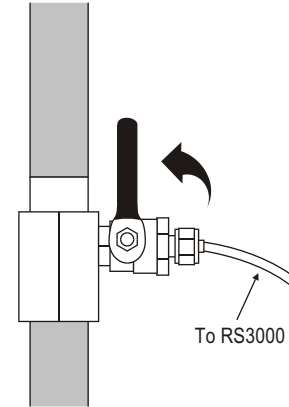

2. Loosen the used pre-filter clockwise and remove it.

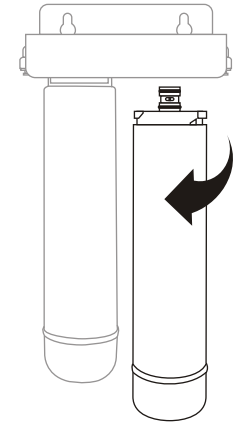

3. Screw in and install the new filter anticlockwise.

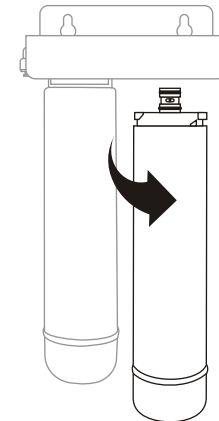

4. Turn on water supply.

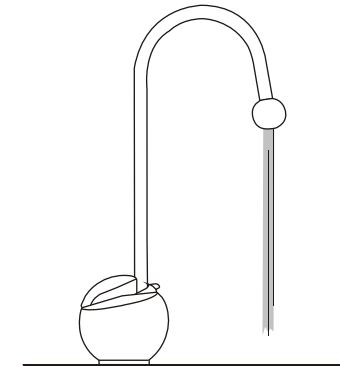

Drain out 1 Gallon of water to purify replacement filters.

Installation diagram

Input water :

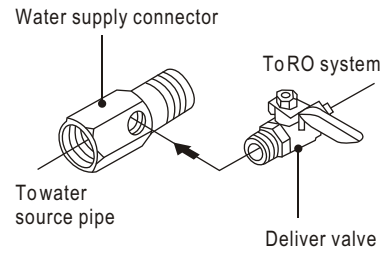

Install European ceramic faucet :

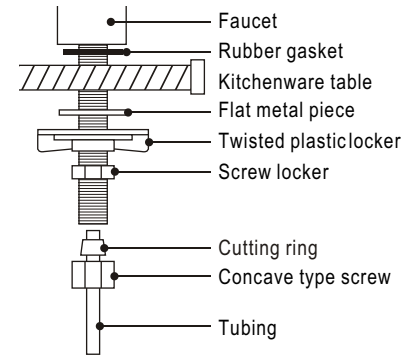

Cartridge filters

Filter Description

RS300ST	RS300ND
<p>Stage 1</p> <p>5 Micron Sediment Filter</p> <p>With only five micron rating. It is effective in removing dirt, rust and sand particles.</p>	<p>Stage 2</p> <p>GAC Carbon Filter</p> <p>It takes out 99% of the chlorine and organic chemicals. It provides enhanced reduction of taste, odor, and color.</p>

Components & Other selections

Components

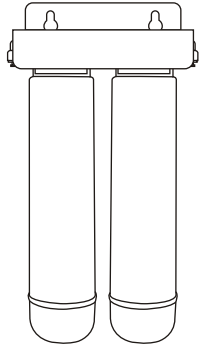

RS2000

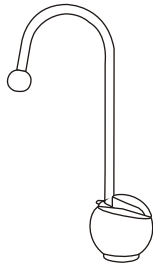

European ceramic faucet

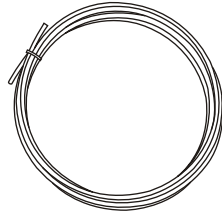

Tubing

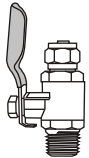

Deliver-valve

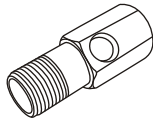

Water supply connector

Other selections

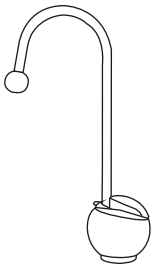

Faucet # 216

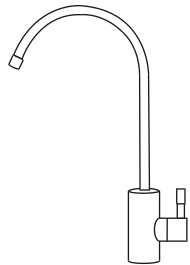

Faucet # 101

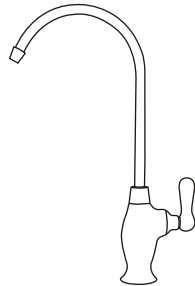

Faucet # 124

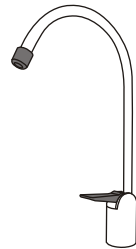

Faucet # 217

RS2000 Easy-change cartridge water filters

Tubing connection diagram

- 1** In Let
- 2** Out Let

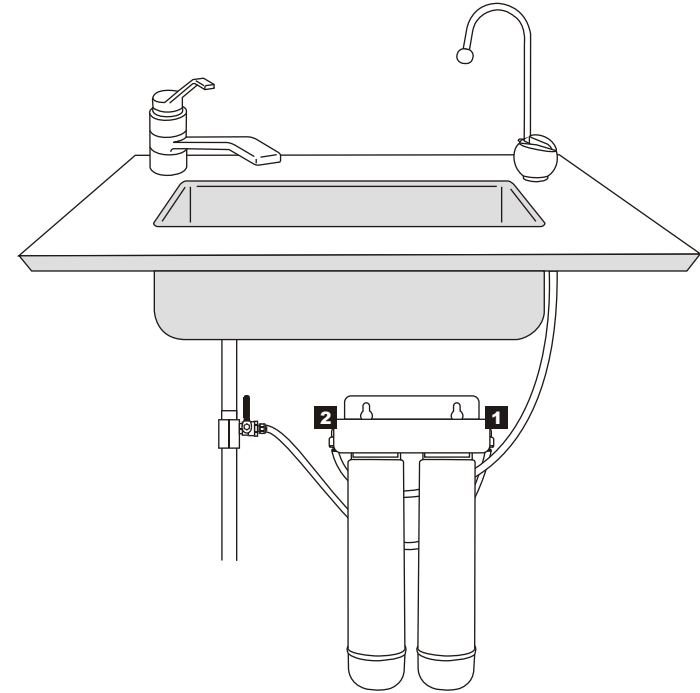

RS2000 Easy-change cartridge water filters