

# Memo

**PUREPRO**  
DRINKING WATER SYSTEM

# S300

Quick-Change Cartridge

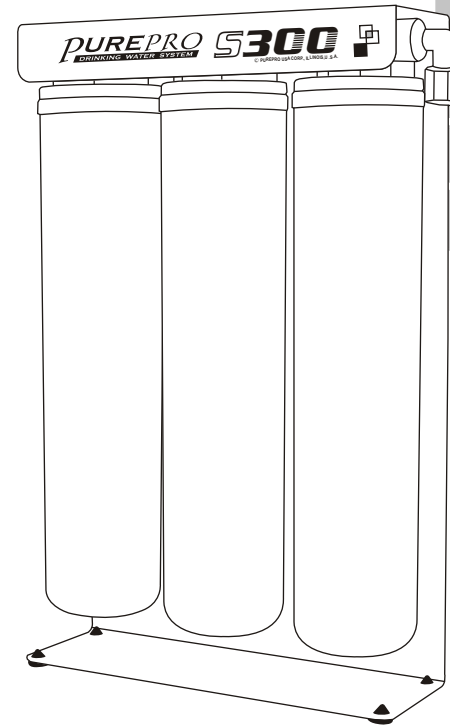

## USER'S MANUAL

- 01 Introduction of S300-D
- 02 Cartridge filters
- 03 Components & Other selections
- 04 Tubing connection diagram
- 05 Installation diagram
- 06 Change filters

Thank you very much for selecting Pure-Pro Water Corp.

In order to bring the best use of your system, please read the user's manual carefully before installation and follow the regulations.

PURE-PRO 07 REVERSE OSMOSIS SYSTEM

Type of product	S300-D		
Date of purchase			
Name		Tel	
Address			

S300 Quick-Change Cartridge Water Filters

**PUREPRO**  
DRINKING WATER SYSTEM

# Introduction of S300-D

## S300-D

### Pre water treatment for water ionizer

Our S300 under sink filters safely and effectively remove microorganisms like Giardia and Cryptosporidium from your water protecting you and your family from parasitic illnesses caused by these contaminants.

The patented quick-change filter technology also improves the taste and overall quality of your water by reducing the amount of Lead, Chlorine, Asbestos and other impurities often found in water supplies.

### Water Ionizer Faucet

PurePro water ionizer faucet is the perfect addition to any countertop water ionizer. In addition to its great looks and high quality, it allows direct connection to water filter from under sink water treatment units.

## Features

- Complete 3 stage water filter system.
- Use twist and quick-change cartridge design makes filter changes fast, clean and easy.
- Feed water connector & deliver valve
- Completely Assembled & Water leaking testing
- Water ionizer faucet
- 100% Factory Tested and Sterilized Ready for Installation.
- European design goldentype faucet.

## Specifications

Dimensions: (cm) 16 (L) x 31.8 (H) x 19.5 (W)

Weight: 3.5 kg

# Change filters

1. Turn off water source.

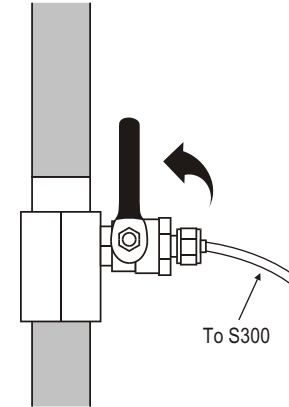

2. Loosen the used pre-filter clockwise and remove it.

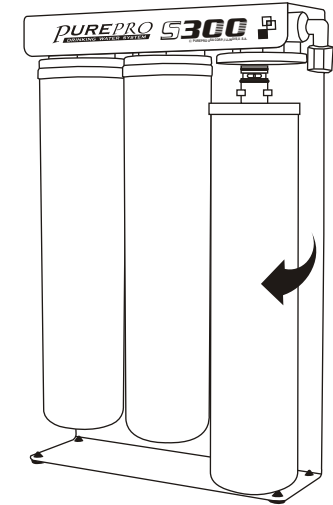

3. Screw in and install the new filter anticlockwise.

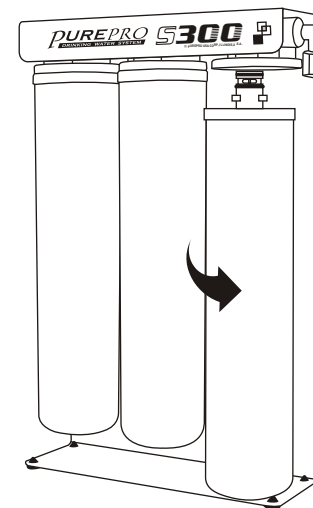

4. Turn on water supply.

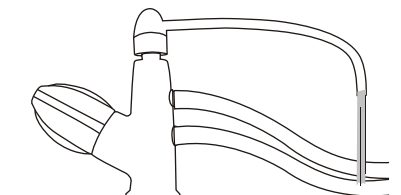

Drain out 1 Gallon of water to purify replacement filters.

# Installation diagram

⊙ **Install jaco fittings:**

Wrap up the jaco fittings with Teflon tape, screw in the fittings to both ends (inlet and outlet) as shown in the picture.

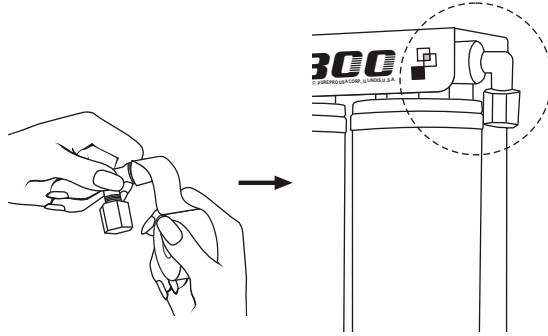

⊙ **Input water :**

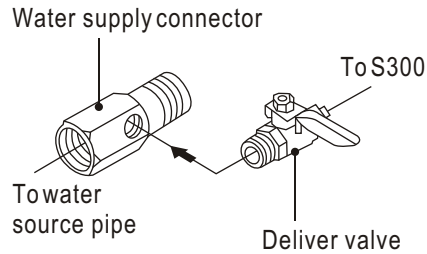

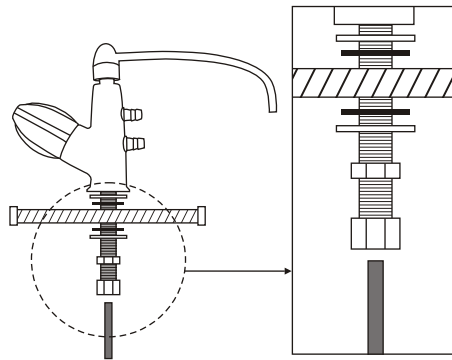

⊙ **Install water ionizer faucet :**



S300 Quick-Change Cartridge Water Filters

# Cartridge filters

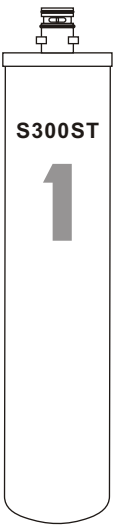
## Filter Description

S300ST	S300ND	S300RD
 <p>S300ST <b>1</b></p>	 <p>S300ND <b>2</b></p>	 <p>S300RD <b>3</b></p>
<p><b>Stage 1</b> <b>5 Micron Sediment Filter</b></p> <p>With only five micron rating. It is effective in removing dirt, rust and sand particles.</p>	<p><b>Stage 2</b> <b>GAC Carbon Filter</b></p> <p>It takes out 99% of the chlorine and organic chemicals. It provides enhanced reduction of taste, odor, and color.</p>	<p><b>Stage3</b> <b>GAC Carbon Filter</b></p> <p>It takes out 99% of the chlorine and organic chemicals. It provides enhanced reduction of taste, odor, and color.</p>

S300 Quick-Change Cartridge Water Filters

# Components & Other selections

## Components

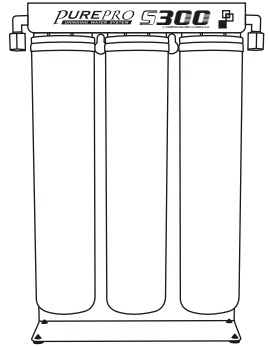

S300

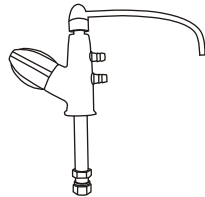

Water Ionizer Faucet

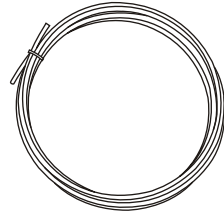

Tubing

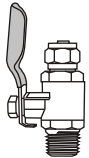

Deliver-valve

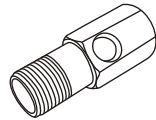

Water supply connector

## Other selections

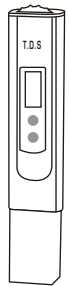

TDS meter

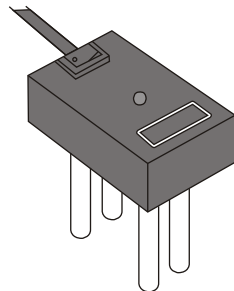

Electronic Color Tester



Shower filter

S300 Quick-Change Cartridge Water Filters



# Tubing connection diagram

- 1** In Let
- 2** Out Let

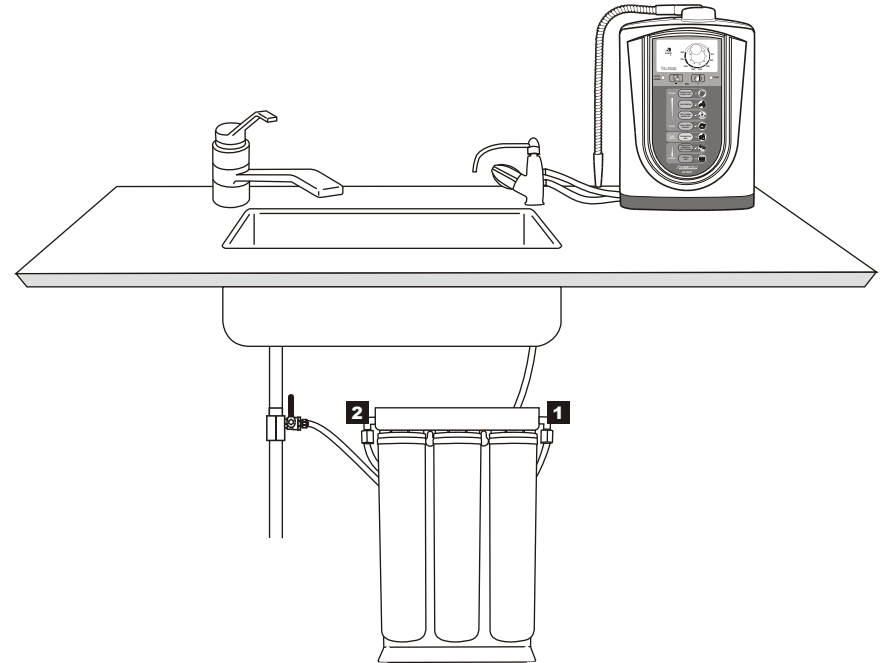

S300 Quick-Change Cartridge Water Filters

